

# ARA

Faretto testa letto da Lettura - Reading Lights

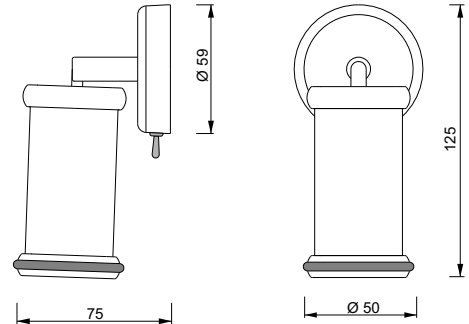

## ARA SMALL

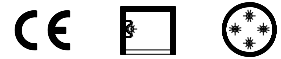

10W

IP20 0,5 m 1x10W G4 12/24 Volt

Art.	Finitura-Finish
------	-----------------

**ARA** 59 7510.C Verchromt Weiss  
59 7510.CP Verchromt Matt Weiss

Art.	Finitura-Finish
------	-----------------

**ARA SMALL** 59 7520.C Verchromt Weiss  
59 7520.CP Verchromt Matt Weiss

In Kokille gegossene Messingleuchten mit milchigem Glas. Geeignet für Leuchtmittel 10W G4. Das Leuchtmittel ist nicht im Lieferumfang enthalten.

Brass body with galvanic treatment.  
Brass ring with galvanic treatment.  
Satiny, tempered glass.  
Ceramic Bulb-holder G4 with lined teflon wires .  
Suitable for inflammable surfaces.  
Can be supplied upon request with LEDs modulus in white, blue and red colour.  
Can be supplied upon request with G4 halogen bulb.

New  
2011

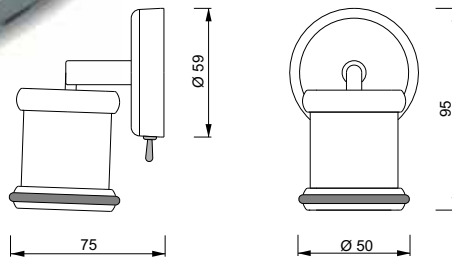

Led

IP20 3200 °K  
LED di potenza 3 Watt 10-30 Vdc

Art.	Finitura-Finish	Colore-Colour LED
------	-----------------	-------------------

59 7510.C.4000 Verchromt Weiss 4000 K°  
59 7510.CP.4000 Verchromt Matt Weiss 4000 K°

Art.	Finitura-Finish	Colore-Colour LED
------	-----------------	-------------------

59 7520.C.4000 Verchromt Weiss 4000 K°  
59 7520.CP.4000 Verchromt Matt Weiss 4000 K°

ARA  
ARA SMALL

In Kokille gegossene Messingleuchten mit milchigem Glas. Inklusiv Regulator und LED 2W Modul und Schalter.

Die-cast brass ring and body with galvanic treatment.  
Satiny, tempered glass.

Supplied with LED power and integrated regulator

Supplied with 3W LED module

White color light 3200 °K degree

Suitable for inflammable surfaces.

Can be supplied upon request with LEDs modulus in white-red.

Can be supplied upon request with white Leds 4000 °K



Als Zubehör erhältlich: LED G4.

Optional pin G4 LED modulus suitable for reading lighting.



LED

Art.	Descrizione-Description
------	-------------------------

LED6.12-24G4.BCO 12/24V 0,24/0,48W Pin G4

# Easy led

Hell leuchtendes LED Spotlicht mit Schalter.  
High Efficiency LED spotlight in thermoplastic.

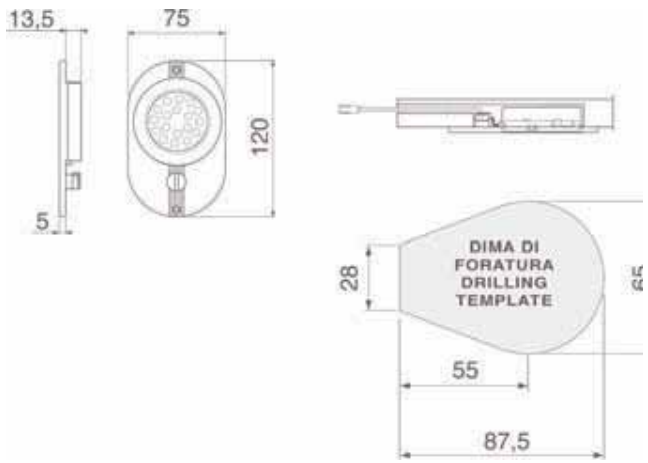
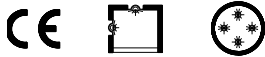

## Led

IP20			87,5x65	LED di potenza	10-30 Vdc
------	--	--	---------	----------------	-----------

Art.	Dim.	N.LED	Potenza/Power	Colore-Colour LED
59 5385	120x75	18	1,25W	5000°k Bianco / White

# DORADO

Innenraumleuchte - Lighting for inside application



## 10W

IP20			0,5 m	Ø 64	1x10W G4	12/24 Volt
------	--	--	-------	------	----------	------------

59 5105.I Inox - Stainless Steel

## LED

IP20			Ø 64	Led smd 5x0,4Watt	4000 °K	10-30 Vdc
------	--	--	------	-------------------	---------	-----------

Art. Finitura-Finish  
59 5105.I.3200 Inox - Stainless Steel

Kunststoffgehäuse mit Aluminiumreflektor.  
Satinertes Glas. Ring aus poliertem Edelstahl AISI 316. Mit Schalter. Wahlweise mit LED (4000 K°) oder für Leuchtmittel 10W G4.

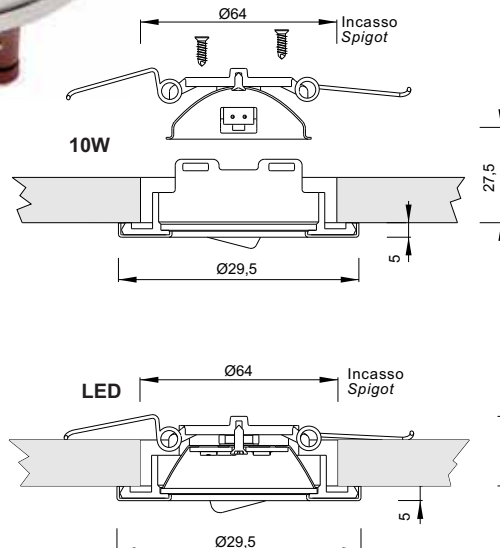

Techno-polymer body.  
Metallized aluminium reflector.  
Satinny, tempered glass.  
Polished stainless steel AISI 316 L ring.  
Fixxing springs in stainless steel.  
Suitable for inflammable surfaces.  
Can be supplied upon request with G4 halogen bulb.  
Switch included.

## Lese- und Kartenlampe | Reading and Chart Light

- Messinggehäuse galvanisch bearbeitet.
  - Flexibler galvanisch bearbeiteter Messingstiel.
  - Geliefert mit echtem Leder in den Farben schwarz, braun und kaffeebraun.
  - Vereinfachte Aufhängung.
  - Geeignet zur Anbringung an normal entflammbare Oberflächen.
  - Auf Anfrage geliefert ohne Schalter.
  - **Geliefert mit linear 3W LED mit integriertem Regulator.**
  - Weisslicht 3500 °K.
- *Machined brass body with galvanic treatment.*
  - *Flexible brass arm with galvanic treatment.*
  - *Supplied with genuine leather lining, in black, brown and coffee.*
  - *Simplified mounting bracket.*
  - *Suitable for mounting on normally inflammable surfaces.*
  - *Supplied upon request without switch.*
  - **Supplied with linear power 3W with LED, with integrated regulator.**
  - *White color light 3500°K.*



Best.-Nr. Order No.	Ausführung Finish	Lederausführung leather finishing
59 7580.C.3500	verchromt   <i>chromed</i>	Spiralschlauch
59 7580.C.PN.3500	verchromt   <i>chromed</i>	schwarz   <i>black</i>
59 7580.C.PC.3500	verchromt   <i>chromed</i>	kaffeebraun   <i>coffee</i>
59 7580.C.PM.3500	verchromt   <i>chromed</i>	braun   <i>brown</i>

**POLARE - B** Suchscheinwerfer für Überrollbügel | **POLARE - B** Lighthouse depth for rollbar



Rotazione +/-100°

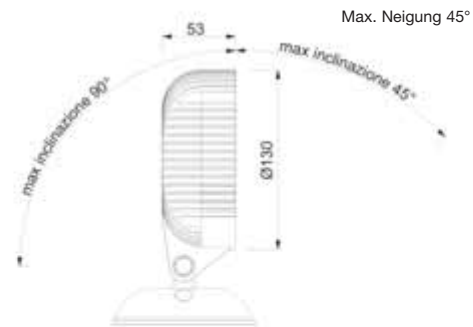

Max. Neigung 45°

**Led**

IP 69 K 4000 °K 9-30 Volt  
Power LED 18Watt

Best.-Nr. Order No.	Ausführung Finish	Beschreibung Description
598810.VB	weiss white	für Überrollbügel for rollbar

**POLARE - P** Suchscheinwerfer mit Reling Befestigung |  
**POLARE - P** Lighthouse depth with pulpit fixing

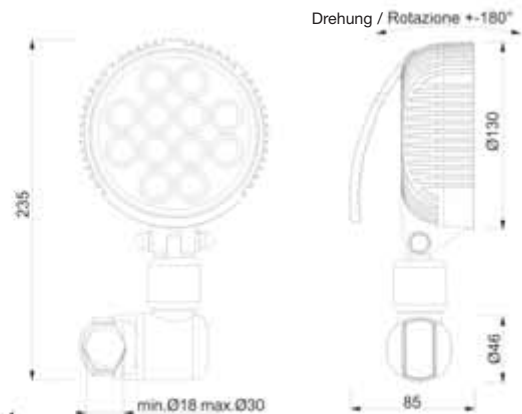

Drehung / Rotazione +/-180°

**Led**

IP 69 K 4000 °K 9-30 Volt  
Power LED 18Watt

Best.-Nr. Order No.	Ausführung Finish	Beschreibung Description
598820.VB	weiss white	für Reling for pulpit

**ORION - B Außenbeleuchtung | ORION-B Light for outside application**



Led

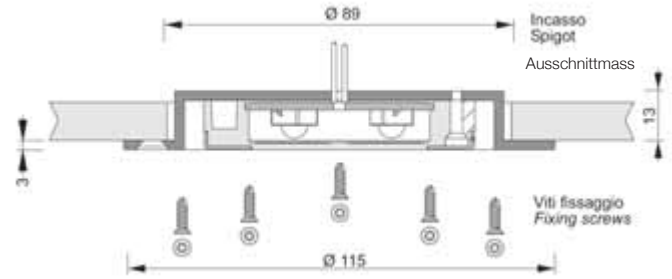

Best.-Nr. Order No.	Ausführung Finish
596050.I	Edelstahl poliert <i>polished stainless steel</i>

AISI 316L Edelstahldrainage mit extrahierbarer Kappe |  
For LED modules a power regulator is necessary.

- AISI 316L Edelstahlgehäuse.
- Polykarbonat Reflektor.
- Geliefert mit AISI 316L Edelstahlschrauben.
- Geeignet für LED Module.
- Kann auf Anfrage mit blauen oder roten LEDs geliefert werden.

- *AISI 316 L stainless steel body.*
- *Polycarbonate reflector.*
- *Supplied with AISI 316 L stainless steel screws.*
- *Suitable with LED modules.*
- *Can be supplied upon request with LEDs in blue or red colour.*



Best.-Nr. Order No.	Eingang / Input 12VDC Ausgang / output 350mA x 3W Eingang / Input 24VDC Ausgang / output 350mA x 6W
596005	

AISI 316L Edelstahldrainage mit extrahierbarer Kappe |  
For LED modules a power regulator is necessary.



**Art.6005**

Input 12VDC output 350mA x 3W  
Input 24VDC output 350mA x 6W

**ANTARES Aussenlicht | ANTARES Ceiling lights for outside application**

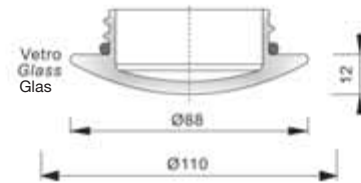
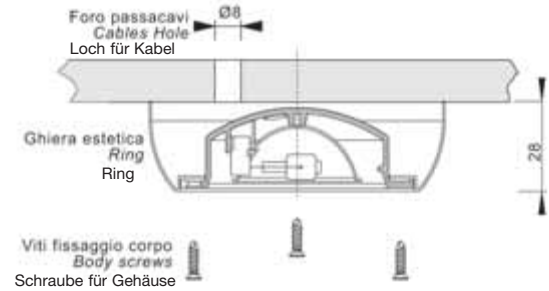
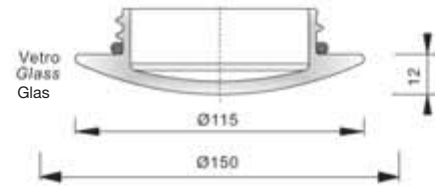
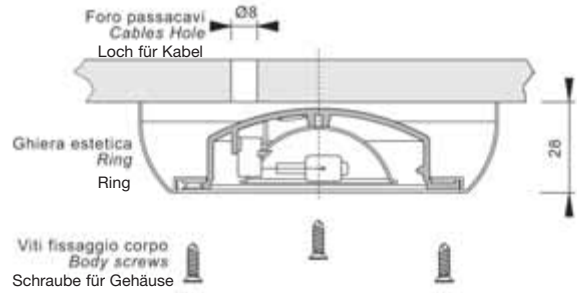

- poliertes und galvanisch bearbeitetes Messinggehäuse.
- Weisses techno/polymer Innengehäuse.
- Silikondichtung für Glas und Gehäuse.
- Glas satiniert, gehärtet und dekoriert.
- Edelstahlschrauben.
- Geeignet für entflammable Oberflächen.
- Geliefert mit SMD LED Modulen.
- Kann auf Anfrage mit RGB LEDs geliefert werden.
- Einheitliche Spannung bei LED 10 bis 30V.

- *Polished brass body with galvanic treatment.*
- *White techno/polymer inside body.*
- *Silicone gasket for the glass and body.*
- *Satiny, tempered and decorated glass.*
- *Stainless steel screws.*
- *Suitable for inflammable surfaces.*
- *Supplied with SMD LEDs modulus.*
- *Can be supplied upon request with RGB LEDs.*
- *Tension unified by 10 to 30V.*

**Led 28**



Best.-Nr. Order No.	Durchm. Dim.	Ausführung Finish	LEDs
	Ø150	Glas /Glass	Weiss / white
59 6106.C.6000		für die Ausführung Weiss LED 6000 K°, 4W.	
59 6106.C.		für die Ausführung für G4 max. 20W.	

**Led 18**



Best.-Nr. Order No.	Durchm. Dim.	Ausführung Finish	LEDs
	Ø110	Glas /Glass	Weiss / white
59 6101.C.6000		für die Ausführung Weiss LED 6000 K°, 4W.	
59 6101.C.		für die Ausführung für G4 max. 20W.	

## PEGASUS-F Leuchten | PEGASUS-F Courtesy Lights

- Klares Techno-polymer-Gehäuse mit 2 Linsen.
- Polierter AISI 316L Edelstahling.
- 3 LED Leuchten lieferbar in den Farben weiss, blau und rot.
- Geeignet für entflammbare Oberflächen.
- Silikondichtung.

- *Clear Techno-polymer body with 2 lens.*
- *Polished AISI 316 L stainless steel ring.*
- *LED 3 lights supplied in white, blue or red colour.*
- *Suitable for inflammable surfaces.*

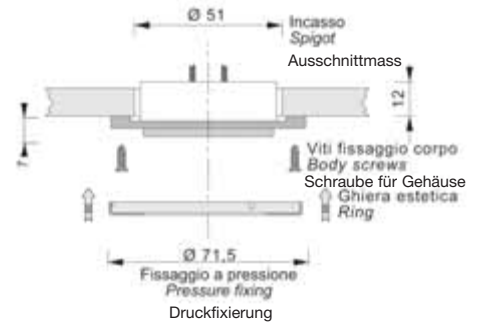

Led



Best.-Nr. Order No.	Ausführung Finish	Farbe LED Colour LED
595710.I.3200	Edelstahl poliert	weiss, 3200 K°
595710.I.6000	Edelstahl poliert	weiss, 6000 K°
595710.IR	Edelstahl poliert <i>polished stainless steel</i>	rot <i>red</i>
595710.IB	Edelstahl poliert <i>polished stainless steel</i>	blau <i>blue</i>

## ANDROMEDA - 1 Umgebungsleuchten | ANDROMEDA- 1 Ambient Lights

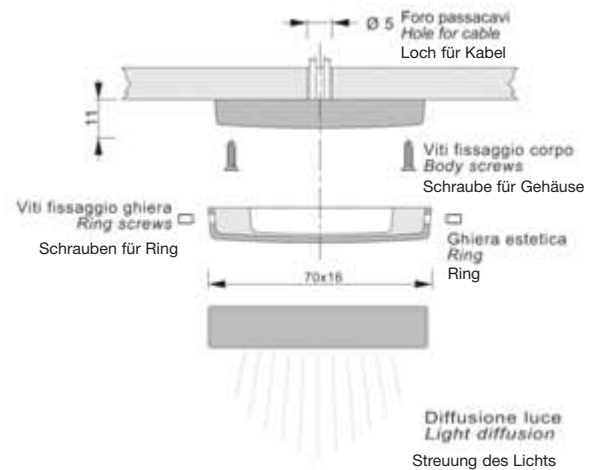

- Klares Techno-polymer-Gehäuse.
- Druckgegossenes und galvanisch bearbeitetes Messinggehäuse.
- Geliefert mit SMD LEDs in den Farben weiss, blau oder rot.
- Geeignet für entflammable Oberflächen.
- Aussenbefestigung ohne Einbuchtung.
- Kann horizontal oder vertikal befestigt werden.
- Erhältlich in verschiedenen Ausführungen auf Anfrage.
- Innovatives design mit besonderer Lichtstreuung (Ambilight).



- *Clear Techno-polymer body.*
- *Die-cast brass body with galvanic treatment.*
- *Supplied with SMD LEDs in white, blue or red colour.*
- *Suitable for inflammable surfaces.*
- *Outside fixing without recess.*
- *Can be fixed horizontal or vertical.*
- *Available in different finish upon request.*
- *Innovative design with paticular light emission to create ambient effects.*

Best.-Nr. Order No.	Ausführung Finish	Farbe LED Colour LED
595721.C.3200	Edelstahl poliert	weiss, 3200 K°
595721.C.6000	Edelstahl poliert	weiss, 6000 K°
595721.CR	verchromt chromed	rot red
595721.CB	verchromt chromed	blau blue
595721.CRT	verchromt chromed	rot weiss red white

## Positionslicht aus Messing | Brass navigation light



Best.-Nr. Order No.	Masse Dim.	Ausführung Finish
5913R.L	152x63x45	poliert <i>polished</i>
5913R.C	152x63x45	verchromt <i>chromed</i>

Backbord rot - 2 Befestigungsschrauben |  
Port Red - 2 fixing screws.



Best.-Nr. Order No.	Masse Dim.	Ausführung Finish
5913RV.L	152x63x45	poliert <i>polished</i>
5913RV.C	152x63x45	verchromt <i>chromed</i>

Zwei-farbig mittig rot/grün - 2 Befestigungsschrauben |  
Bi-colours central Red/Green - 2 fixing screws.



Best.-Nr. Order No.	Masse Dim.	Ausführung Finish
5913B.L	152x63x45	poliert <i>polished</i>
5913B.C	152x63x45	verchromt <i>chromed</i>

Mittig weiss - 2 Befestigungsschrauben |  
Central white - 2 fixing screws.



Best.-Nr. Order No.	Masse Dim.	Ausführung Finish
5913V.L	152x63x45	poliert <i>polished</i>
5913V.C	152x63x45	verchromt <i>chromed</i>

Steuerbord grün - 2 Befestigungsschrauben |  
Starboard Green - 2 fixing screws.

## Rundumlicht aus Messing | Brass all round navigation light

Best.-Nr. Order No.	Masse Dim.	Ausführung Finish
5916.L	H108Ø62 <i>polished</i>	poliert
5916.C	H108Ø62	verchromt <i>chromed</i>

Weiss - 2 Befestigungsschrauben | White - 2 fixing screws.



Messing Türverschluss | Brass push lock for cup board doors with white mechanism

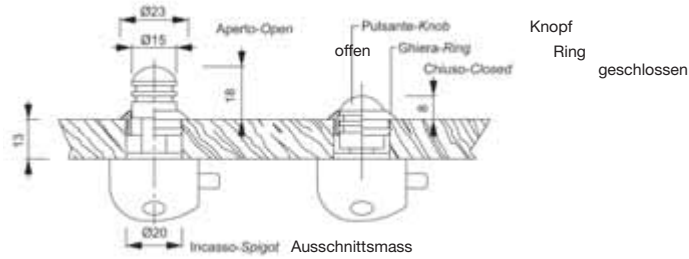

Best.-Nr. Order No.	Durchmesser Dim.	Tür Door	Knopf Knop	Ring Ring
59330.C	Ø23	13	verchromt <i>chromed</i>	verchromt <i>chromed</i>
59330.D	Ø23	13	vergoldet <i>gold plated</i>	vergoldet <i>gold plated</i>
59330.V	Ø23	13	lackiert <i>lacquered</i>	lackiert <i>lacquered</i>
59330.CD	Ø23	13	vergoldet <i>gold plated</i>	verchromt <i>chromed</i>
59330.CP	Ø23	13	verchromt-Satin <i>pearl-chrome</i>	verchromt-Satin <i>pearl-chrome</i>

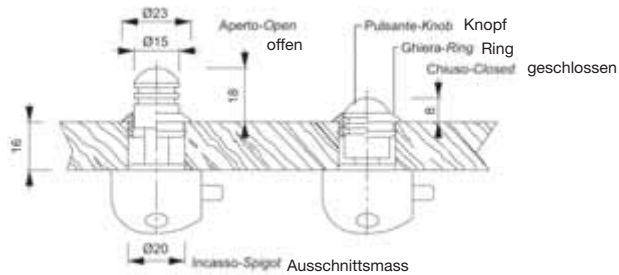

Best.-Nr. Order No.	Durchmesser Dim.	Tür Door	Knopf Knop	Ring Ring
59331.C	Ø23	16	verchromt <i>chromed</i>	verchromt <i>chromed</i>
59331.D	Ø23	16	vergoldet <i>gold plated</i>	vergoldet <i>gold plated</i>
59331.V	Ø23	16	lackiert <i>lacquered</i>	lackiert <i>lacquered</i>
59331.CD	Ø23	16	vergoldet <i>gold plated</i>	verchromt <i>chromed</i>
59331.CP	Ø23	16	verchromt-Satin <i>pearl-chrome</i>	verchromt-Satin <i>pearl-chrome</i>

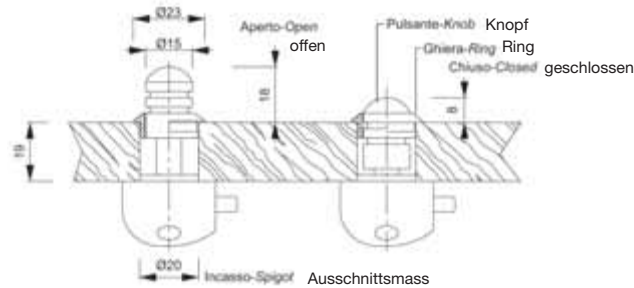

Best.-Nr. Order No.	Durchmesser Dim.	Tür Door	Knopf Knop	Ring Ring
59332.C	Ø23	19	verchromt	verchromt <i>chromed chromed</i>
59332.D	Ø23	19	vergoldet <i>gold plated</i>	vergoldet <i>gold plated</i>
59332.V	Ø23	19	lackiert	lackiert <i>lacquered lacquered</i>
59332.CD	Ø23	19	vergoldet	verchromt <i>gold platedchromed</i>
59332.CP	Ø23	19	verchromt-Satin <i>pearl-chrome</i>	verchromt-Satin <i>pearl-chrome</i>

## Messing Klappfenster oval | Brass oval porthole

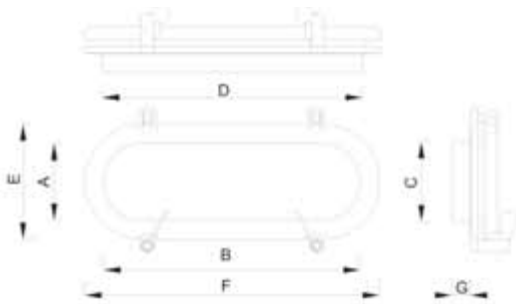

Auf Anfrage in Glas erhältlich |  
Available with glass upon request for decorative purpose.

Best.-Nr. Order No.	A	B	C	D	E	F	G	Ausführung Finish
596A.25.L	100	230	104 r=52	233	150	280	25	poliert <i>polished</i>
596A.25.C	100	230	104 r=52	233	150	280	25	verchromt <i>chromed</i>
596A.43.L	100	230	104 r=52	233	150	280	43	poliert <i>polished</i>
596A.43.C	100	230	104 r=52	233	150	280	43	verchromt <i>chromed</i>
596B.25.L	115	330	120 r=60	340	163	380	25	poliert <i>polished</i>
596B.25.C	115	330	120 r=60	340	163	380	25	verchromt <i>chromed</i>
596B.50.L	115	330	120 r=60	340	163	380	50	poliert <i>polished</i>
596B.50.C	115	330	120 r=60	340	163	380	50	verchromt <i>chromed</i>
596C.25.L	120	430	130 r=65	440	170	482	25	poliert <i>polished</i>
596C.25.C	120	430	130 r=65	440	170	482	25	verchromt <i>chromed</i>
596C.50.L	120	430	130 r=65	440	170	482	50	poliert <i>polished</i>
596C.50.C	120	430	130 r=65	440	170	482	50	verchromt <i>chromed</i>

Stärke des äusseren Gegenrings 3 mm. |

## Messing Bullauge rund | Brass round porthole

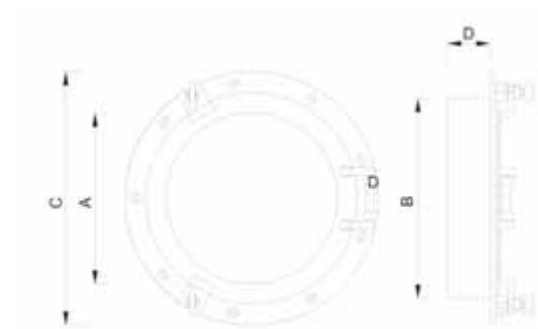

Auf Anfrage in Glas erhältlich |  
Available with glass upon request for decorative purpose.

Best.-Nr. Order No.	A	B	C	D	Ausführung Finish
597A.25.L	168	195	264	25	poliert <i>polished</i>
597A.25.C	168	195	264	25	verchromt <i>chromed</i>
597A.50.L	168	195	264	50	poliert <i>polished</i>
597A.50.C	168	195	264	50	verchromt <i>chromed</i>
597B.25.L	200	235	300	25	poliert <i>polished</i>
597B.25.C	200	235	300	25	verchromt <i>chromed</i>
597B.50.L	200	235	300	50	poliert <i>polished</i>
597B.50.C	200	235	300	50	verchromt <i>chromed</i>
597C.25.L	350	385	470	25	poliert <i>polished</i>
597C.25.C	350	385	470	25	verchromt <i>chromed</i>
597C.47.L	350	385	470	47	poliert <i>polished</i>
597C.47.C	350	385	470	47	verchromt <i>chromed</i>

7A-7B: Stärke des äusseren Gegenrings 4 mm.  
7C: Stärke des äusseren Gegenrings 5 mm |  
7a-7b: Outside counter ring thickness 4 mm.  
7c: Outside counter ring thickness 5 mm.

## quadratische Messing Decksluke | Brass square deck hatch

Best.-Nr. Order No.	Ausschnittmass Spigot	Öffnungsmass Opening	Glasgröße Glass size	Ausführung Finish	Plexiglas Plexiglass
591A.L	498x498	490x490	455x455	poliert <i>polished</i>	klar <i>clear</i>
591A.C	498x498	490x490	455x455	verchromt <i>chromed</i>	klar <i>clear</i>
591A.LF	498x498	490x490	455x455	poliert <i>polished</i>	dunkel <i>dark</i>
591A.CF	498x498	490x490	455x455	verchromt <i>chromed</i>	dunkel <i>dark</i>

Auf Anfrage in Glas erhältlich | Available with glass upon request



## trapezförmige Messing Decksluke | Brass trapezoidal deck hatch

Best.-Nr. Order No.	Ausschnittmass Spigot	Öffnungsmass Opening	Glass size Glass size	Ausführung Finish	Plexiglas Plexiglass
591B.L	440x400x440	435x395x435	400x400x360	poliert <i>polished</i>	klar <i>clear</i>
591B.C	440x400x440	435x395x435	400x400x360	verchromt <i>chromed</i>	klar <i>clear</i>
591B.LF	440x400x440	435x395x435	400x400x360	poliert <i>polished</i>	dunkel <i>dark</i>
591B.CF	440x400x440	435x395x435	400x400x360	verchromt <i>chromed</i>	dunkel <i>dark</i>

Auf Anfrage in Glas erhältlich | Available with glass upon request



## Teleskop – Lukenfeststeller aus Messing | Brass telescopic hatch adjuster

Best.-Nr. Order No.	Länge Lenght	Ausführung Finish
592A.L	320x500	poliert <i>polished</i>
592A.C	320x500	verchromt <i>chromed</i>
592B.L	360x640	poliert <i>polished</i>
592B.C	360x640	verchromt <i>chromed</i>



## Messing Steckschnalle für Spiegel | Brass hood and canvas frame sockets



Best.-Nr. Order No.	Masse Dim.	Ausführung Finish
59161A.L	40x25	poliert <i>polished</i>
59161A.C	40x25	verchromt <i>chromed</i>

Seitenhalterung mit 4 Schrauben |  
*Side mounting 4 screws.*



Best.-Nr. Order No.	Durchmesser Dim.	Ausführung Finish
59161B.L	Ø31	poliert <i>polished</i>
59161B.C	Ø31	verchromt <i>chromed</i>

Bajonethalterung mit 2 Schrauben |  
*Bayonet location mounting 2 screws.*

## Messing Antennenhalter | Brass aerial bases



Best.-Nr. Order No.	Durchmesser Dim.	Ausführung Finish
59166A.L	Ømin18 Ømax30	poliert <i>polished</i>
59166A.C	Ømin18 Ømax30	verchromt <i>chromed</i>

Für Bugkorb justierbare Klampe |  
*For pulpits adjustable clamp*



## Messing Flaggenstockhalter | Brass flagpole socket

Best.-Nr. Order No.	Durchmesser Dim.	Ausführung Finish
59191A.L	Ø14	poliert <i>polished</i>
59191A.C	Ø14	verchromt <i>chromed</i>

Railing von Rohrdurchmesser 20 und 25 |  
*Railings of ø20 and ø25 tubing*

Best.-Nr. Order No.	Durchmesser Dim.	Ausführung Finish
59191B.L	Ø20	poliert <i>polished</i>
59191B.C	Ø20	verchromt <i>chromed</i>

Railing von Rohrdurchmesser 20 und 25 |  
*Railings of ø20 and ø25 tubing*

## Messing Flaggenstockhalter | Brass flagpole holder



Best.-Nr. Order No.	Masse Dim.	Ausführung Finish
59158A.L	Ø55x55	poliert <i>polished</i>
59158A.C	Ø55x55	verchromt <i>chromed</i>

Geneigt 10° Durchmesser Flaggenstock 25 |

Best.-Nr. Order No.	Masse Dim.	Ausführung Finish
59158B.L	Ø45x45	poliert <i>polished</i>
59158B.C	Ø45x45	verchromt <i>chromed</i>

Geneigt 10° Durchmesser Flaggenstock 20 |  
*Inclined 10° spigot Ø20*

Best.-Nr. Order No.	Masse Dim.	Ausführung Finish
59158C.L	Ø40x40	poliert <i>polished</i>
59158C.C	Ø40x40	verchromt <i>chromed</i>

Geneigt 10° Durchmesser Flaggenstock 16 |  
*Inclined 10° spigot Ø16*



## Messing Flaggenstock für Reling | Brass flagpole with socket

Best.-Nr. Order No.	Durchmesser Dim.	Ausführung Finish
59200A.L	L350xØ13	poliert <i>polished</i>
59200A.C	L350xØ13	verchromt <i>chromed</i>
59200B.L	L500xØ13	poliert <i>polished</i>
59200B.C	L500xØ13	verchromt <i>chromed</i>
59200C.L	L800xØ13	poliert <i>polished</i>
59200C.C	L800xØ13	verchromt <i>chromed</i>
59200D.L	L1000xØ13	poliert <i>polished</i>
59200D.C	L1000xØ13	verchromt <i>chromed</i>

## Messing Bootshakenspitze | Brass boats hook

Best.-Nr. Order No.	Masse Dim.	Ausführung Finish
5964C.L	L170Ø28	poliert <i>polished</i>
5964C.C	L170Ø28	verchromt <i>chromed</i>

Einfach | *Simple*



## Messing Bodenheber | Brass flush lifting ring

Best.-Nr. Order No.	Masse Dim.	Ausführung Finish
59170.L	57x40	poliert <i>polished</i>
59170.C	57x40	verchromt <i>chromed</i>

Mit Feder | *With spring*



## Messing Klappring | Brass lifting ring

Best.-Nr. Order No.	Durchmesser Dim.	Ausführung Finish
59241A.L	Ø53	poliert <i>polished</i>
59241A.C	Ø53	verchromt <i>chromed</i>

Mit Feder | *With spring*



Best.-Nr. Order No.	Durchmesser Dim.	Ausführung Finish
59241B.L	Ø53	poliert <i>polished</i>
59241B.C	Ø53	verchromt <i>chromed</i>

Mit Feder, verborgene Fixierung | *With spring, hidden fastening*



## Messing Klampe mit Holz | Brass bollards with wooden ledge

Best.-Nr. Order No.	A	B	C	D	Ausführung Finish
59150A.L	300	73	30	45	poliert <i>polished</i>
59150A.C	300	73	30	45	verchromt <i>chromed</i>
59150B.L	250	73	30	45	dunkel <i>dark</i>
59150B.C	250	73	30	45	verchromt <i>chromed</i>

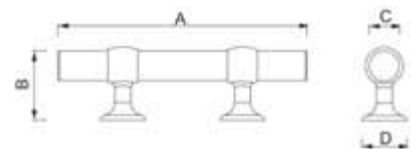

**Edelstahl Scharnier | Stainless steel flush hinge**

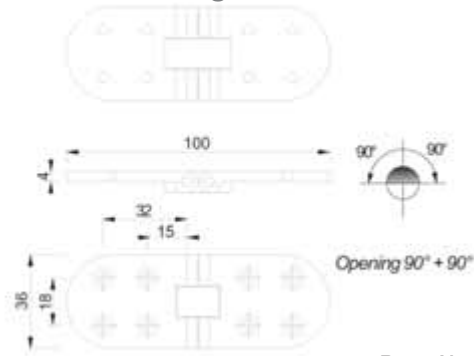

Best.-Nr. Order No.	Masse. Dim.	Ausführung Finish
599436A.I	100x36	Edelstahl Stainless Steel

**Messing Magnettürhalter | Brass magnetic adjustable barrel bolt**

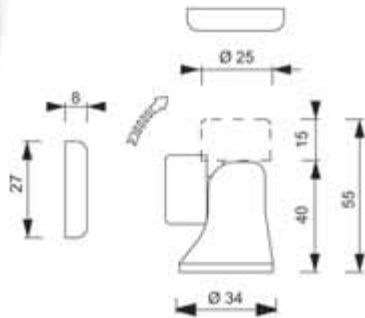

© Modello depositato  
Model Depose

Best.-Nr. Order No.	Masse Dim.	Ausführung Finish
59252.L	Ø34x55	poliert polished
59252.C	Ø34x55	verchromt chromed
59252.D	Ø34x55	vergoldet gold plated
59252.V	Ø34x55	lackiert lacquered
59252.CP	Ø34x55	verchromt-Satin pearl-chrome



Best.-Nr. Order No.	Masse. Dim.	Ausführung Finish
59386.L	33x72	poliert polished
59386.C	33x72	verchromt chromed

Messing Türriegel für Schiebetür mit schwarzer Gummieinlage. Designed in rechteckiger Form mit der Grösse 72x33 mm H 11 mm max. Geliefert mit 2 Edelstahlschrauben ASI TPS für Befestigung. Die Befestigungsplatte ist mit einem schwarzen Gummi versehen, der Vibrationen verhindert.

Brass door latch for sliding doors with black rubber insert. Designed in rectangular shape with size 72x33 mm H 11mm max. Supplied with 2 stainless steel AISI TPS screws (flush hexagon) to be direct fixing. Supplier with black rubber plate for fixing base, useful to avoid vibrations on rest position.

verstellbarer Messing Magnettürhalter | Brass magnetic adjustable barrel bolt

Best.-Nr. Order No.	Masse Dim.	Ausführung Finish
59405.L	38x38x26	poliert <i>polished</i>
59405.C	38x38x26	verchromt <i>chromed</i>
59405.D	38x38x26	vergoldet <i>gold plated</i>
59405.CP	38x38x26	verchromt-Satin <i>pearl-chrome</i>

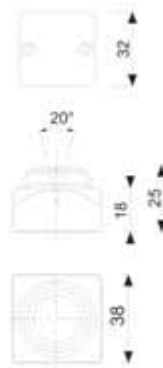

Best.-Nr. Order No.	Masse Dim.	Ausführung Finish
59406.L	38x38x70	poliert <i>polished</i>
59406.C	38x38x70	verchromt <i>chromed</i>
59406.D	38x38x70	vergoldet <i>gold plated</i>
59406.CP	38x38x70	verchromt-Satin <i>pearl-chrome</i>

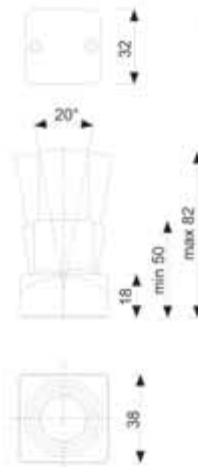

Best.-Nr. Order No.	Masse Dim.	Ausführung Finish
59410.L	Ø39x26	poliert <i>polished</i>
59410.C	Ø39x26	verchromt <i>chromed</i>
59410.D	Ø39x26	vergoldet <i>gold plated</i>
59410.CP	Ø39x26	verchromt-Satin <i>pearl-chrome</i>

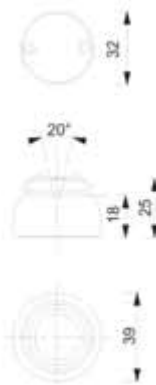

Best.-Nr. Order No.	Masse Dim.	Ausführung Finish
59411.L	Ø39x70	poliert <i>polished</i>
59411.C	Ø39x70	verchromt <i>chromed</i>
59411.D	Ø39x70	vergoldet <i>gold plated</i>
59411.CP	Ø39x70	verchromt-Satin <i>pearl-chrome</i>

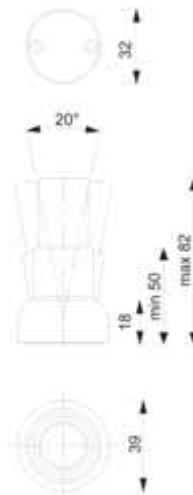

## Messing Kleiderhaken | Brass coat hook



Best.-Nr. Order No.	Masse Dim.	Ausführung Finish
59205.L	81x39	poliert <i>polished</i>
59205.C	81x39	verchromt <i>chromed</i>



Best.-Nr. Order No.	Masse Dim.	Ausführung Finish
59349.L	75x25	poliert <i>polished</i>
59349.C	75x25	verchromt <i>chromed</i>
59349.D	75x25	vergoldet <i>gold plated</i>
59349.CP	75x25	verchromt-Satin <i>pearl chromed</i>

Mit Edelstahlfeder | *With stainless steel spring*

## Messing verchromte COX Serie I Chromed brass serie COX



Best.-Nr. Order No.	Ausführung Finish
594085.C	verchromt <i>chromed</i>

Wasserhahn mit ausziehbarer Brause |  
*Single-lever sink mixer, extractable shower*

## Messing verchromte DAX R Serie I Chromed brass serie DAX R



Best.-Nr. Order No.	Ausführung Finish
594368.C	verchromt <i>chromed</i>

Wasserhahn mit Feder und Brause |  
*Single-lever sink mixer, with spring and shower*

**versenkbare Verschlusseinheit aus Edelstahl I**  
Stainless steel Flush fitting hatch lockind device

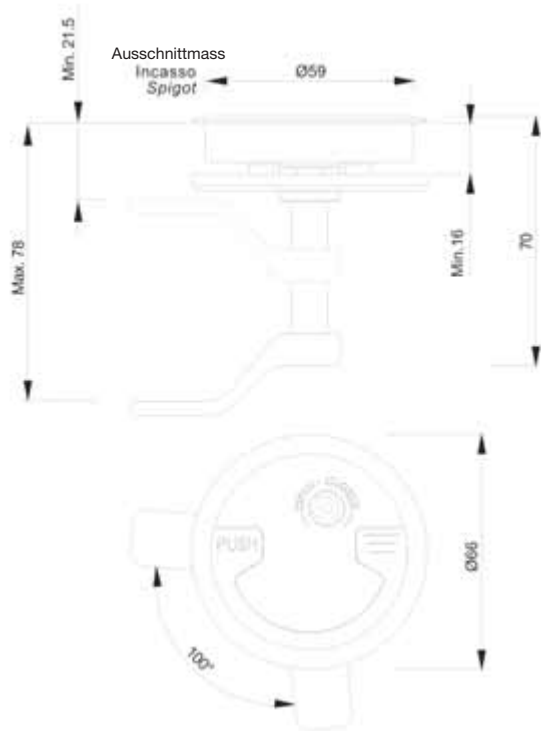

**Best.-Nr.** AISI 316L Edelstahl Verschlusseinheit mit Schloss |  
**Order No.** AISI 316L Stainless Steel flush fitting device with lock.  
599203A.I

**Verschlusseinheit mit Deckel I** Stainless steel Closing

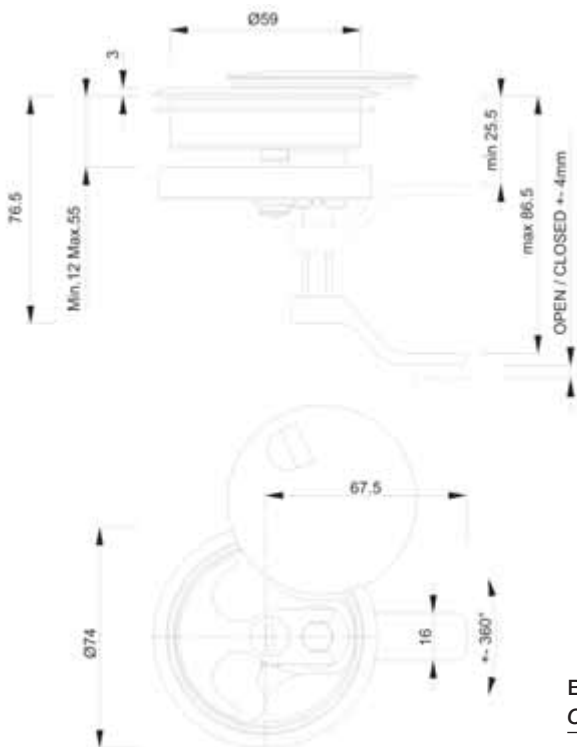

**Best.-Nr.** AISI 316L Edelstahl Verschlusseinheit mit Deckel und Schloss |  
**Order No.** AISI 316L Stainless Steel Tight compression closure with cover and lock.  
599204A.I

Edelstahl Abfluss mit Abdeckkappe | Stainless steel Drainage Bushing



**9105.1**



**9108.1**



**9110.1**

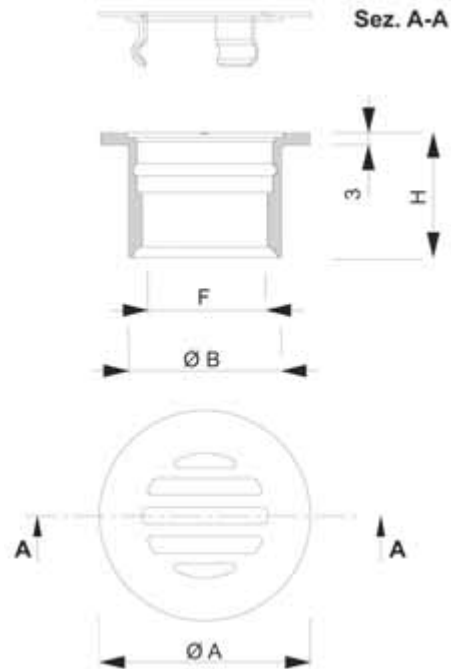

Best.-Nr. Order No.	Masse A x B x H x F Dim. A x B x H x F
599105.1	50 x 36 x 31 x G1"
599108.1	75 x 53 x 30 G1-1/2"
599110.1	85 x 64 x 33 x G2"

AISI 316L Edelstahl-Drainage mit extrahierbarer Kappe |  
AISI 316L Stainless drainage bushing with extractable cup.

